

USER MANUAL

# brainLight®-4D-Shiatsu-Massage-Chair



**brainLight®**

LIFE IN BALANCE

◆◆◆ Since 1988 ◆◆◆

# brainLight®-4D-Shiatsu-Massage-Chair SPHERE

Thank you very much for choosing the **brainLight**-4D-Shiatsu-Massage-Chair **SPHERE**.

Your Wellness-Sphere: The **brainLight**-4D-Shiatsu-Massage-Chair **SPHERE**, wrapped in OEKO-Tex 100 certified leatherette! It allows massages from neck to buttocks, from the tip of your fingers to the tip of your toes. Individually adjusted, when using the Health Check function or manually chosen, according to your needs in any moment: This feels good right now, in just this intensity. Add to this the Negative-Ions-Function, which can heighten your sense of well-being. Combined with the light and sound of the **brainLight**-Systems, **SPHERE** offers you a perfect experience of well-being.

Let our **SPHERE** take you to new spheres!

## NOTE:

In order to get the best experience out of the various functions of your massage chair right from the start, please read this manual carefully, in particular the safety instructions.

## WARRANTY AND GUARANTEE

The warranty and guarantee periods adhered to by **brainLight** GmbH are as follows:

### Private customers:

- 24 months warranty for new goods.
- 12 months warranty for used goods.
- 24 months guarantee for new goods.
- 6 months guarantee for used goods.

### Commercial customers:

- 12 months warranty for new goods.
- 6 months warranty for used goods.
- 6 months guarantee for new and used goods.

If you have any questions regarding your **brainLight**-System or if a repair is necessary, please contact the **brainLight**-Customer Service:

**By phone: Service-Hotline +49 (0)6021 5907-10**  
(Monday to Friday, 9 am to 5 pm – CET)

**By e-mail: kundenservice@brainlight.de**  
We will get back to you promptly.

# Content

Safety Instructions		The Chair Functions	
Contraindications .....	4	Quick Guide .....	14
Installation and Operation .....	4	Using the Menu to Navigate .....	15
Before Using the Chair .....	5	Manual Massage Settings.....	23
During Use of the Chair .....	5	Shortcut Buttons on top of right side panel .....	24
After Using the Chair.....	5	Control Panel – Symbols on Shortcut Buttons .....	25
No Unqualified Dismantling or Repairs .....	5	Negative-Ions-Function .....	26
Heating Function .....	6	Troubleshooting, Maintenance, & Care	
The Chair Components .....	7	Troubleshooting: No Power .....	27
Moving the Chair .....	8	Cleaning and Care .....	27
Placing the Chair .....	9	Product- and Packaging Measurements .....	30
General Instructions before Use .....	10	Technical Specifications .....	31
Control Panel – Overview .....	12		
Symbols on Control Panel – Display .....	13		

# Safety Instructions

**In order to avoid damage, accidents and injuries, the following safety instructions should be adhered to:**

**1. Contraindications – People with any of the following conditions are advised to consult their physician or therapist before using the 4D-Shiatsu massage chair SPHERE:**

- People with heart diseases
- People with severe tumors
- Women during pregnancy or menstruation
- People with back pains, abnormalities or curvature of the spine
- People undergoing medical treatment and medicinal therapy
- People with osteoporosis, diabetes, and / or sensory impairments.

**Not allowed to use**

- **the calf- and foot-sole massage function:** People suffering from thrombosis or similar vein conditions
- **any massage functions:** Children under the age of 14
- **the massage chair:** People weighing more than 120 kg / 19 stone / 265 lbs.

**Children, people who are ill and people with relevant disabilities should only use the chair under the supervision of an adult or carer.**

**2. Installation and Operation:**

- Use the chair only indoors. It is not designed to be used in any outside area.
- If the room that the chair is usually in, is kept rather cool, please turn the room temperature up gradually a few degrees at a time and not right away to a high setting.
- If transporting the chair from a cold environment or room into a warm room remember to wait for about an hour before using it, like you do with any other electrical device. Condensation may occur on the mechanical parts of the chair through the fast temperature change and might cause a malfunction.
- Do not place the chair in rooms where aerosols are used or devices for oxygen therapies (e.g. an oxygen-inhaling-apparatus).
- Place the chair only on a flat, level surface.
- Do not set up the chair in a dirty, oily, humid or damp environment.
- Do not expose the chair to direct sunlight and do not place it too close to other electrical appliances.
- Please do not use the chair when the surrounding temperature is above 40° C / 104° F.

# Safety Instructions

## 3. Before Using the Chair:

Please read the safety instructions carefully before using the massage chair.

## 4. During Use of the Chair:

- Do not allow children to play on the chair.
- Children under the age of 14 can use the heating function of the chair BUT ONLY while under the supervision of an adult.
- Keep hands and feet away from the mechanics of the chair.
- Please do not put your weight on the calf massage part in order to prevent injuries and / or damage to the chair.
- Do not use the chair in a wet condition (right after a bath or a shower) and do not operate the chair with damp hands.
- Sit in the chair in an upright position.
- Do not insert any objects into the mechanics, seat cushion or footrest of the chair.
- The massage chair should not be used by more than one person at a time.
- Do not eat or drink while using the massage chair.

## 5. After Using the Chair:

- After every use of the chair we recommend to drink plenty of water – as after any type of massage – in order to help with the removal of toxins and waste from the now activated limbic system.
- Please unplug the power cord from the wall socket when the chair is not in use.

## 6. No Unqualified Dismantling or Repairs!

- Do not attempt to dismantle, repair, or modify the chair without the qualified technical guidance of the **brainLight** GmbH. If repairs are carried out without the appropriate expertise and skill, you might lose the eligibility for claims based on statutory warranty.
- Do not clean the chair with alcoholic or steam producing solutions (See -Cleaning and Care- on page 27 ff.).
- Unplug the power cord when cleaning the chair or during maintenance.

# Safety Instructions

## CAUTION:

- If you feel unwell or ill when using the chair, please pause your application immediately by pushing the On / Off button (see p. 12).
- If the cover material of the chair is outworn or damaged anywhere, unplug the power cord from the wall socket and contact **brainLight** GmbH.
- Put a towel underneath your head when using hair gel or oil- or wax-based hair products to protect the cover material of the chair.
- Please handle the control panel with care and press the buttons only with dry hands. A light touch with your fingertips is enough to operate the chair. Please do not use any sharp objects to operate the control panel (pens, fingernails, etc.).

## HEATING FUNCTION

**To avoid getting too hot when using a massage program with the HEAT function, we recommend that you wear appropriate clothing.**

- People with relevant disabilities and people with limited sensory perception should not use the HEAT function to avoid feeling uncomfortably hot.
- Do not use the HEATING function for more than 30 minutes at a time and let it cool down before turning it on again. Continuously using the HEAT function may result in overheating.
- For optimum comfort we recommend to use the HEATING function in combination with the massage functions.

# The Chair Components

Accessory (1): Accessory bag for the **brainLight**-Visualization-Glasses or your own glasses during a session

Negative-Ions-Outlet

Airbags for shoulder massage

Foldable backrest pad

Shortcut buttons

Airbags for arm- and hand massage

Airbags for calf massage

Airbags and massage rolls for foot-sole massage

Accessory (2): Foam pads to insert in the foot area to soften the intensity of the massage there if so desired

Headrest with pillow

Holder for control panel

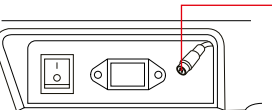

Main switch box at the back of the chair base

Chair base with casters



Accessory (3): Connection cable to the **brainLight**-Deep-Relaxation-System

# Moving the Chair

- First turn the power off at the main switch at the back of the chair base and then pull the power cord out of the wall socket.
- Remember to cover the floor with suitable material before moving the chair to avoid any damage to the surface.
- Tilt the chair -as shown in the picture below – and roll it to the desired position on its casters

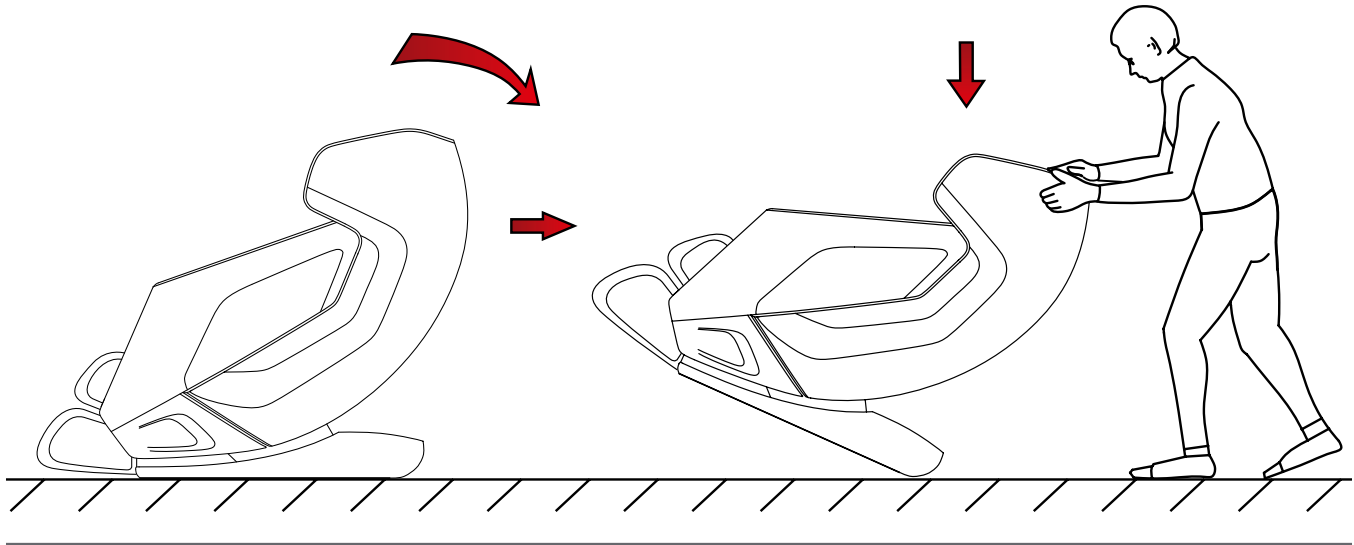



## Placing the Chair

Please make sure to have at least 35 cm (approx. 1.15 feet) space in front of the chair. Keep a space of at least 5 cm (approx. 2 inches) behind the chair, so that the

backrest can move backwards during the massage program without any obstruction.

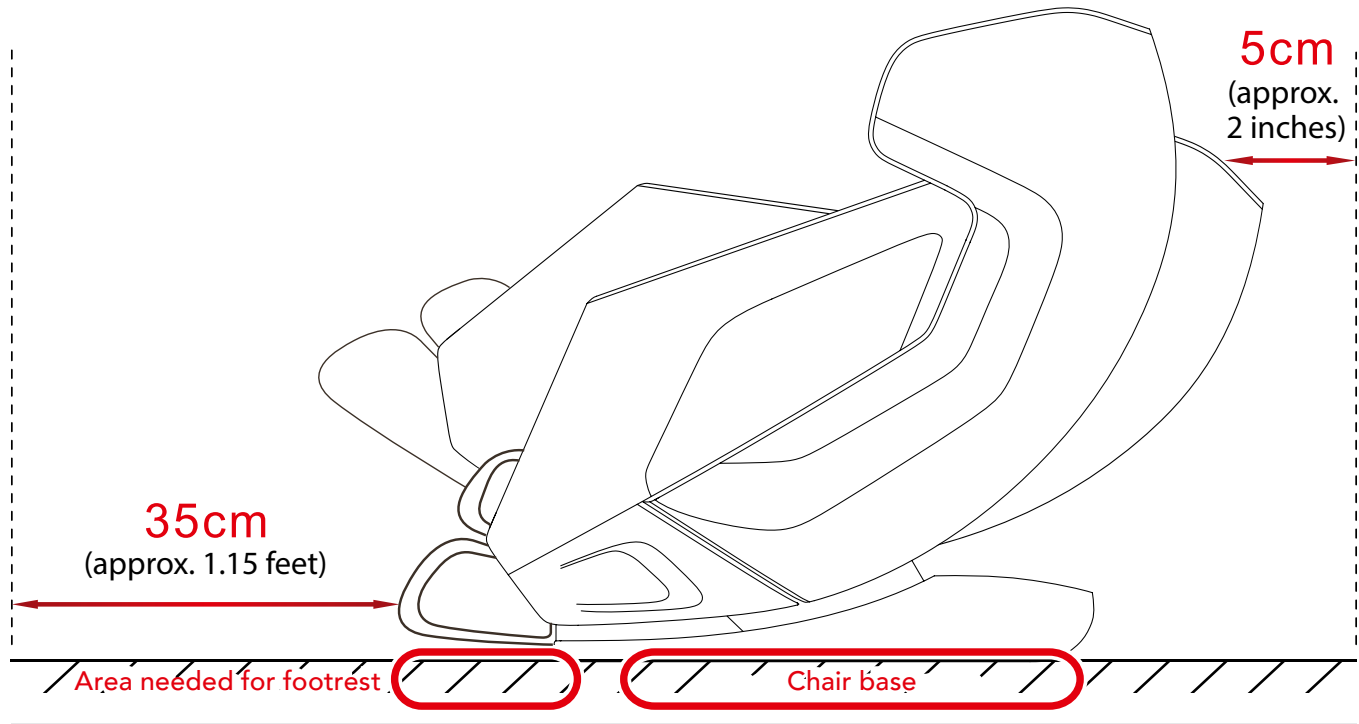

## General Instructions before Use

### CONNECTING THE **brainLight-DEEP-RELAXATION-SYSTEM** WITH THE MASSAGE CHAIR:

1. Connect your **brainLight-Synchro** or the **brainLight** relaxTower with the provided adapter cable (part of the delivery contents).
2. Connect the main power plug to the massage chair and plug the other end into a wall socket.
3. Turn on the main ON / OFF switch at the base of the chair.

Plug in the cable to the **brainLight-Deep-Relaxation-System** here.

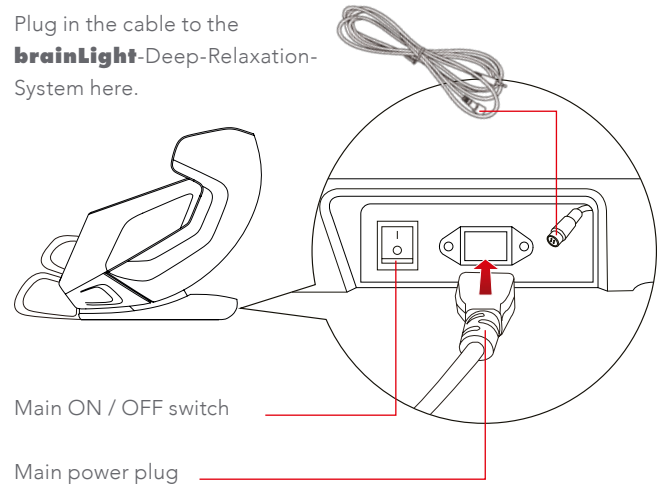

**NOTE:** You can remove the control panel totally, if your **brainLight-4D-Shiatsu-Massagesessel SPHERE** is connected to a **brainLight-Synchro** or relaxTower and you exclusively want to use its fully automatic and synchronized **brainLight** - Light and Sound Massage Programs.

# General Instructions before initial Use

## ATTACHING THE COVER PAD AND PILLOW:

- Zip up the cover pad on the right and left side of the back rest and the seating area of the massage chair.

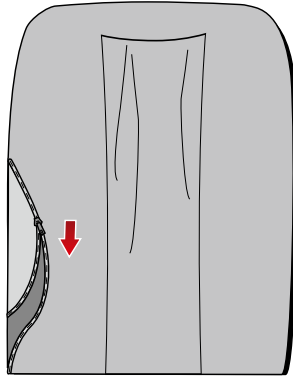

- Zip up the foldable backrest pad at the top of the back pad.

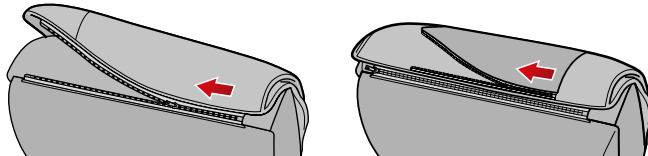

- Attach the pillow to the back padding with velcro.

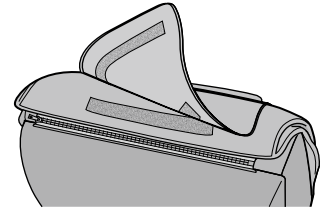

- The backrest pad can be folded up and serve as a second pillow or it can be fully removed if you desire a more intense back massage (see picture p. 23).

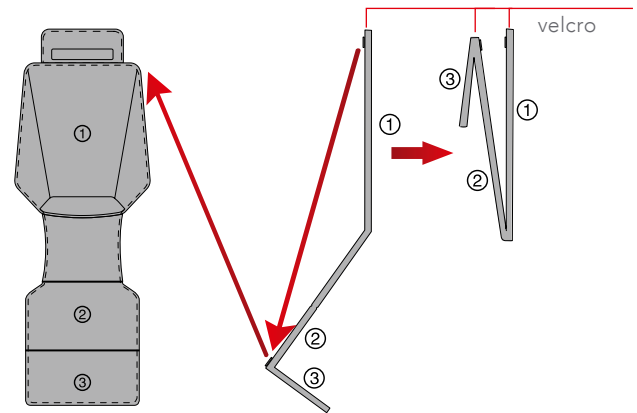

# Control Panel – Overview

Control panel display ①

## NOTE:

The Control Panel is **NOT** a touch panel! Navigating within the available menu functions is done via the 4-Way-Direction button (3).

## THE SHORTCUT BUTTONS:

Play / Pause ②

⑦ Menu

⑧ On / Off

4-Way-Direction ③

⑨ OK (Confirmation Button)

Moving footrest UP ④

⑩ Recline Angle UP

Moving footrest DOWN ⑤

⑪ Recline Angle DOWN

Changing reclining angle of the chair ⑥

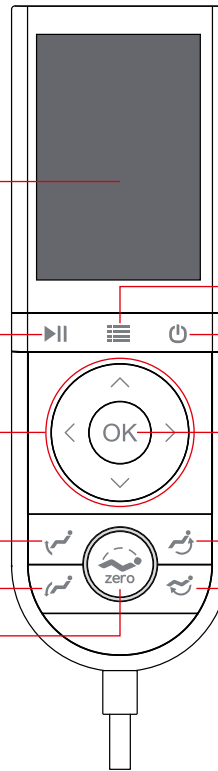

# Symbols on Control Panel-Display

2  **Play / Pause Button:** Press this button to pause the massage. The massage continues when you press the button again.

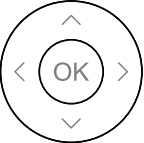
3  **4-Way-Direction-Button:** This button allows you to navigate within the menu in four directions. Confirm your selection by pressing the OK-Button (9).

4  **Moving footrest UP / DOWN:** Press these buttons to manually adjust the angle for your lower legs.

6  **Zero Button:** Press this button to choose one of the three available reclining positions.

7  **Menu Button:** Press this button to select any available functions within the menu.

8  **On / Off Button:** Press this button to start your massage chair or to stop it.

9  **OK Button:** Press this button to confirm your selection within the menu.

10  **Recline Angle UP / DOWN Button:** Press these buttons to manually adjust the angle for your reclining position.

11 

## NOTE:

When using the automatic programs not all Shortcut Buttons can be used (details see p. 15).

# The Massage Functions: Quick Guide



1. Press the **On / Off Button** (8) drücken.
2. Use the **4-Way-Direction-Button** (3) to select an automatic program and start it by pressing the **OK Button** (9).
3. The body scan starts. Once the body scan is completed you can adjust the massage rolls manually to your personal liking by using the UP / DOWN keys **^** and **v** of the **4-Way-Direction-Button** (3). Once they are in an optimal position, you confirm this by pressing the **OK Button** (9).
4. Now **modifications** are possible like selecting another automatic program or changing the duration of the program etc.; This can be done in two ways: use the **Shortcut-Control Panel** (p. 24) or use the **Menu of the Control Panel** (p. 15ff.) to select the desired function.

You can pause the selected program at any time by pressing the **Play / Pause Button** and continue by pressing the button again. Please turn your massage chair off after use.

# The Massage Functions: Using the Menu to Navigate

## GENERAL:

By using the **4-Way-Direction button** (3) you can move around on your menu display. With the **OK Button** (9) you confirm your choice and the next screen appears, giving you new options. With this method you can navigate through the different screens and choose your individual settings.

Going to the **Menu Button AUTO** on your Control Panel you have the choice of 12 pre-programmed

automatic programs and a selection of 3 categories. Use the **4-Way-Direction-Button** (3) to navigate to the selected functions and confirm your choice by pressing the **OK Button** (9).

## NOTE:

While using the automatic programs **"Stretch"** and **"Sleep Aid"** the seating angle cannot be changed manually. In addition: the 3D-intensity cannot be changed while using **"Stretch"**.

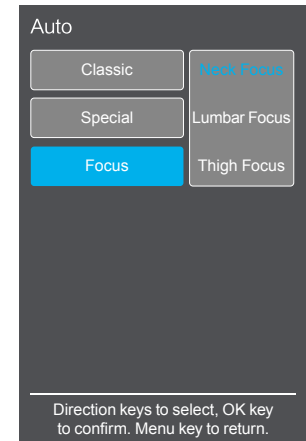
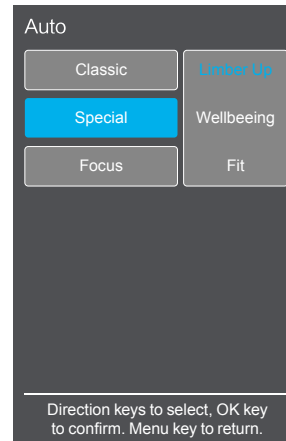
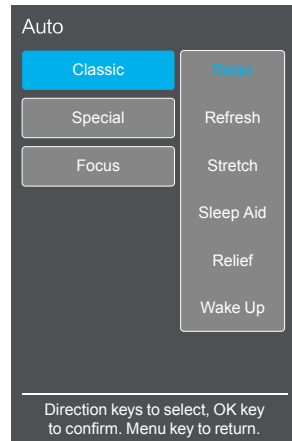
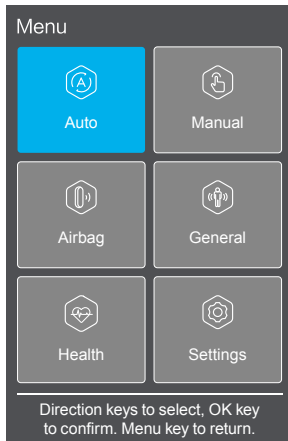

# The Massage Functions: Using the Menu to Navigate

The **brainLight-4D-Shiatsu-Massage Chair SPHERE** lets you choose from 6 different types of massages: Kneading, Tapping, Knocking (Pounding), Clapping, Interval and Shiatsu for back-and buttocks area with up to 6 speed settings.

Those different types of massages can be chosen in your menu by going to **MANUAL** and then to **MODE** for your selection.

By going to **REGION** you can choose the body area that you would like to have massaged. This can be a complete body massage or only a certain area or even only a certain point. (Whole / Part / Point). To direct the massage rolls to a certain point, you go first to „Whole“ and wait till the massage rolls reach the point of your choice. Then press „Point“.

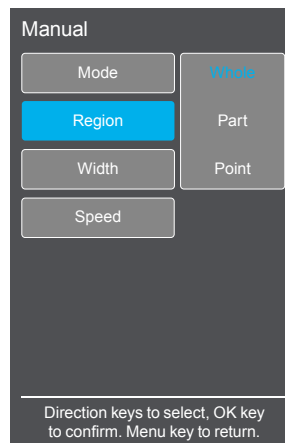
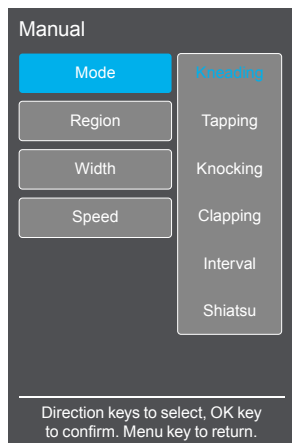
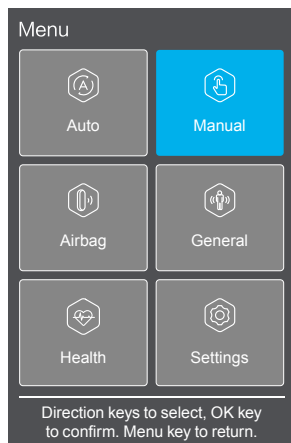



# The Massage Functions: Using the Menu to Navigate

The distance between the massage rolls can be chosen by going to **WIDTH** and set in 3 different intervals:

Width = 18 cm

Medium = 10 cm

Marrow = 5 cm

This selection is not possible when using the mode "Kneading" or "Knocking" (Pounding).

By pressing **SPEED** you can choose between 6 different settings within any of the massage types.

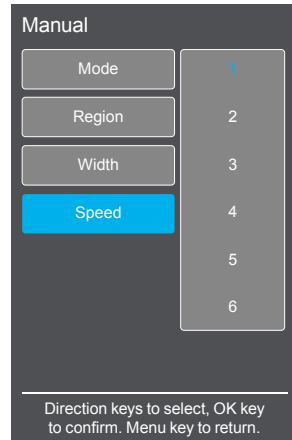
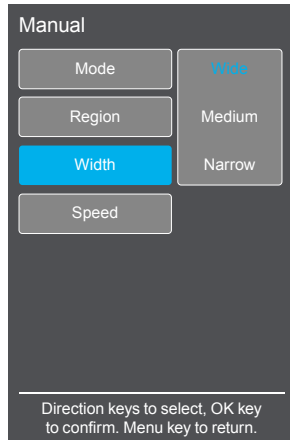

# The Massage Functions: Using the Menu to Navigate

The **brainLight-4D-Shiatsu-Massage Chair SPHERE** uses airbags to massage the more sensitive body parts like shoulders, arms, hands, legs, and feet with air pressure.

To get to this setting, choose **AIRBAG** on the menu.

Then go to **REGION** to choose the area you want massaged. With the setting **AUTO** all areas of the body are being massaged.

By going to **INTENSITY** you can choose between three different intensities or turn this function totally OFF. When no setting for **INTENSITY** is chosen, the system automatically uses level 2.

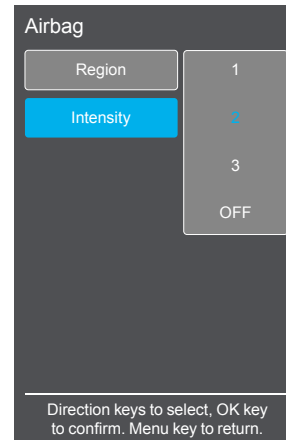
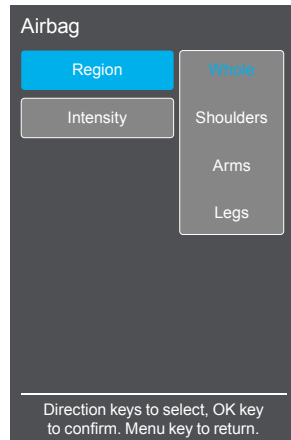
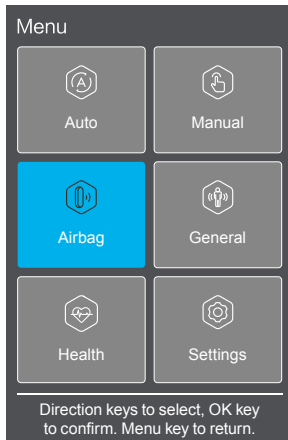

# The Massage Functions: Using the Menu to Navigate

To activate the **HEALTH CHECK** on the menu you use the **4-Way-Direction-Button** (3) to navigate to the desired function and confirm your choice by pressing the **OK Button** (9). A **HEALTH CHECK** is done by placing your finger lightly on the sensor (Detection Module). While the red light is glowing, your heart rate and the oxygen saturation in your blood is measured. After this check you can choose the offered, individualized massage that is based on those measurements.

If the check failed, you can re-start the process by pressing the **OK Button** (9).

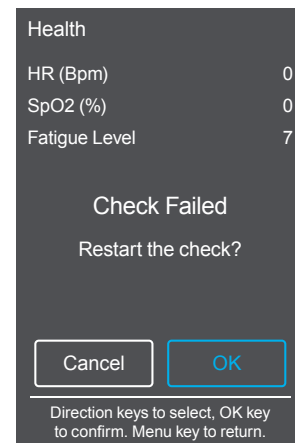
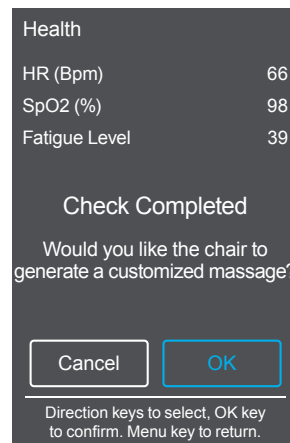
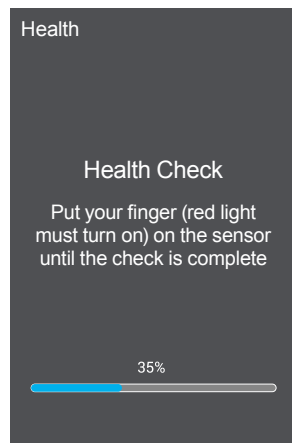
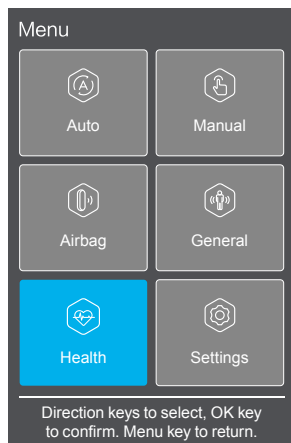

# The Massage Functions: Using the Menu to Navigate

Go to **GENERAL** to choose one of the three reclining positions available. The **ZERO-POSITION** (8) (Zero Gravity) is the lowest position possible. It imitates the reclining position that astronauts are in during lift-off. That way, the strong and sudden rise in gravity is safely distributed throughout the body. The **brainLight-4D-Massage Chair SPHERE** is using the same effect to distribute your weight optimally within the chair. This relieves your body and allows for a more

intense massage experience. The stress reduction on your body is so effective, that you almost feel weightless. Another advantage of this Zero position is that it supports the blood circulation in your legs and reduces swelling. This might even help to prevent varicose veins among other things, since your legs are higher than your heart in this position.

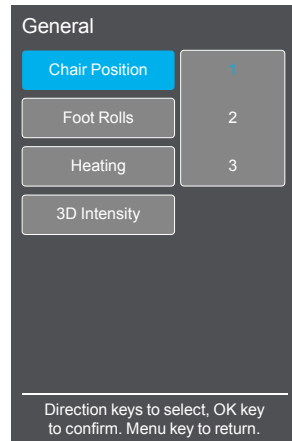
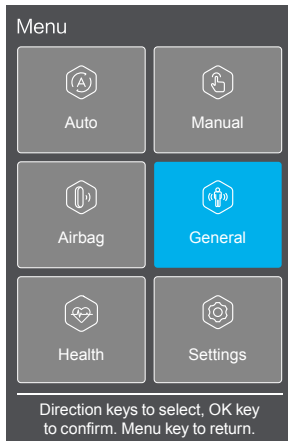

# The Massage Functions: Using the Menu to Navigate

Go to **FOOT ROLLS** in your menu to add the **FOOT-SOLE MASSAGE** or to turn it off. You have three different speed settings to choose from.

By selecting **HEATING** on the menu you can add the **HEATING FUNCTION** or turn it off when using the automatic programs as well as the manual ones. This will revitalize your cells and improve the blood circulation in the lumbar region.

Choose from **THREE INTENSITY CYCLES**:

**Cycle 1:** 1 minute on, 2 minutes off

**Cycle 2:** 2 minutes on, 3 minutes off

**Cycle 3:** 5 minutes on, 1 minute off

By going to **3D INTENSITY** on your menu, you can choose from 6 different levels of depth for the massage rolls in the back area.

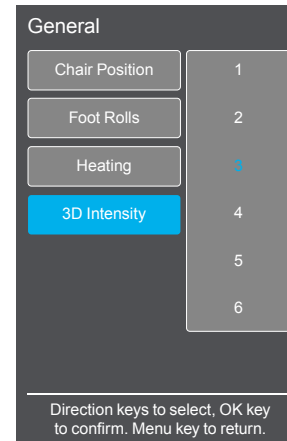
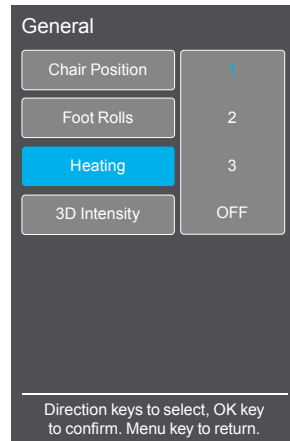
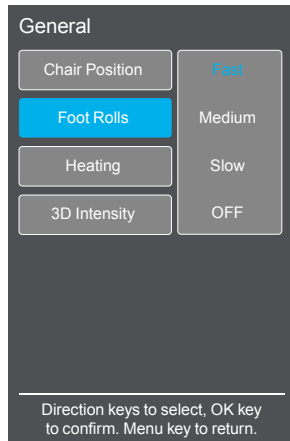

# The Massage Functions: Using the Menu to Navigate

By going to **SETTINGS** on your menu, the general parameters for your **brainLight-4D-Shiatsu-Massage Chair SPHERE** can be selected. Use the **4-Way-Direction button** (3) to move around on your menu display. With the **OK Button** (9) you confirm your choice.

With this method, you can navigate through the different menu options and choose your individual settings.

By going to **TIME** on your menu, you can select the desired massage time.

By going to **NEGATIVE IONS** on your menu, you can turn the air purification function on or off.

By going to **LANGUAGES** on your menu, you can choose from 5 different languages: German / English / French / Polish / Czech.

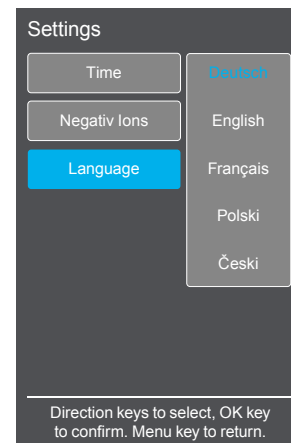
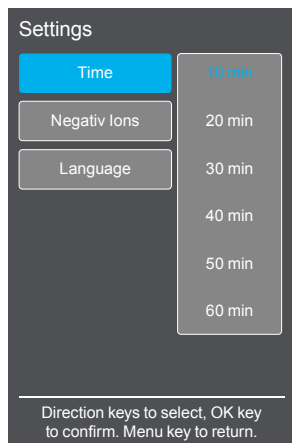
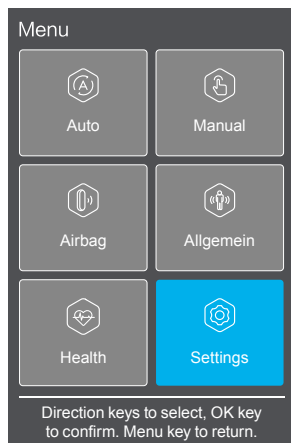

# Manual Massage Settings

## INTENSITY OF THE FOOT-SOLE MASSAGE

If a softer foot-sole massage is desired, foam pads can be inserted, which are part of the delivery contents.



## INTENSITY OF THE BACK MASSAGE

If a stronger back massage is desired you can:

- fold back the small pillow behind your head.
- fold the backrest pad into a second head cushion or remove it totally (see also p. 11).





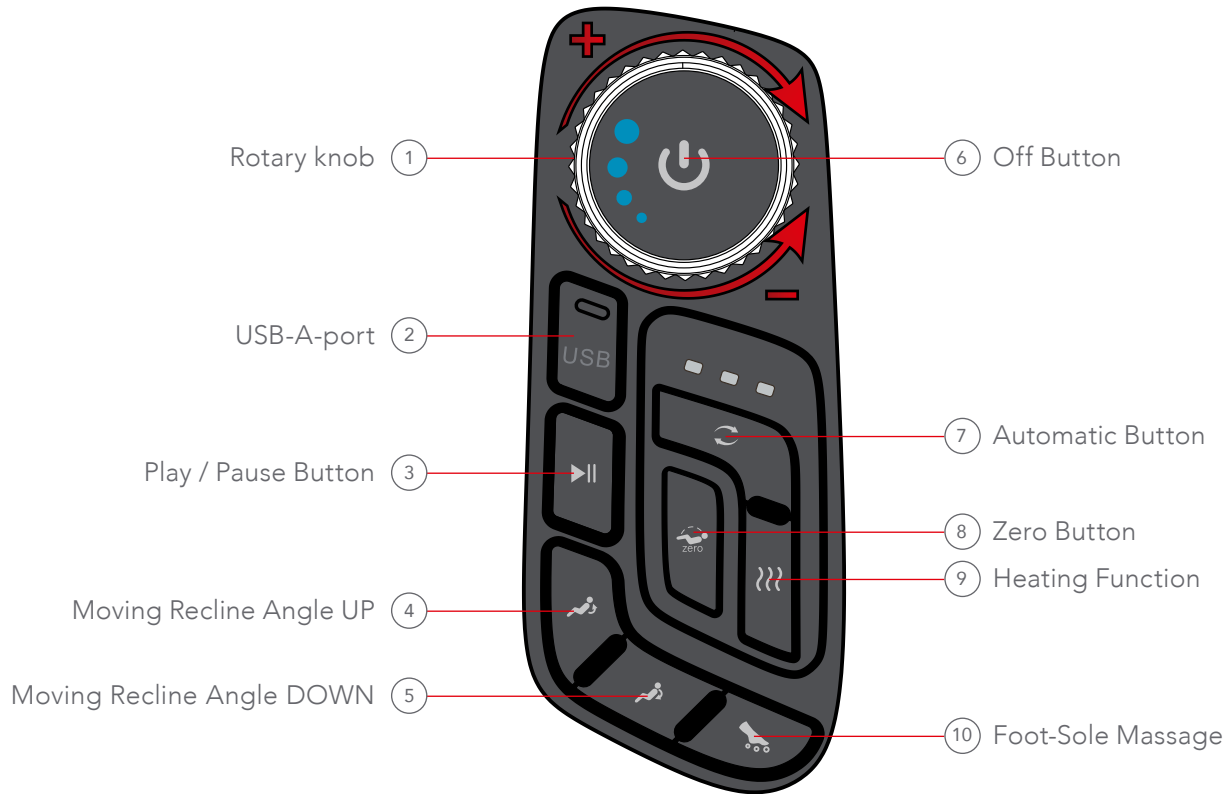



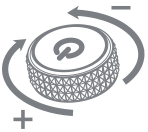

# Shortcut Buttons on top of right side panel



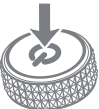

# Symbols on Shortcut Buttons

-  **Rotary knob:** Turn this knob clockwise, to gradually increase the 3D-intensity of the massage in the back-and buttocks area. Turn it counter clockwise to gradually decrease it.
-  **USB-A-port:** Port to charge your smartphone
-  **Play / Pause Button:** Press this button to pause the massage. By pressing the button again, the massage continues.
-  **Moving Recline Angle UP / DOWN:** Press these buttons to manually adjust the seating angle.
-  **Off Button:** Press this button to turn the massage chair off.
-  **Automatic Button:** Press this button to choose one of the three automatic programs or switch between them: RELAX, REFRESH or STRETCH.
-  **Zero Button:** Press this button to manually choose one of the three reclining positions.
-  **Heating Function:** Press this button to turn the heating function on or off.
-  **Foot-Sole Massage Button:** Press this button to turn the foot-sole massage on or off.

**NOTE:**

While using the automatic programs not all shortcut buttons can be used (details see p. 15).

## Negative-Ions-Function



Outlet for the Negative Ions

The **IONIZATION FUNCTION** (air purification) of the **brainLight-4D-Shiatsu-Massage Chair SPHERE** creates a neutral electrostatic atmosphere all around the seating area. Thus, fine particles, aerosols, bacteria, germs, and viruses are removed. Odors are neutralized within minutes as well.

This can contribute to boosting emotional wellbeing, performance, ability to concentrate, and being in a good mood; it also promotes restful sleep.

Breathing can get easier, and thus reduce tiredness; it also might lower blood pressure, which in turn delays aging processes.

By going to **NEGATIVE IONS** on your menu, you can turn the air purification function on or off.

# Troubleshooting, Maintenance, & Care

## TROUBLESHOOTING: NO POWER

**Step 1:** Make sure the chair is switched on. The main power switch is located on the bottom left side of the backrest (see p. 7). The icon "I" is pushed inwards when switching on the chair. If you still have no power, continue with step 2.

**Step 2:** Check both ends of the power cord and make sure it is firmly plugged into the chair as well as into the socket. If you still have no power, continue with step 3.

**Step 3:** Test the socket with another electrical appliance. If the socket works but the chair does not, please contact the **brainLight** GmbH (see p. 2).

## CLEANING AND CARE OF CHAIR AND CONTROL PANEL

**CAUTION:** It is important to disconnect the chair from any power by pulling the power cord out of the wall socket, before you clean the chair or control panel.

You can clean the leatherette cover as well as all the other parts on the outside of the chair, by using a soft cloth to remove any dust, dirt or stains. The control panel, being turned off, can be gently wiped with a slightly moist cloth and dried with a dry, soft one.

The massage chair is wrapped in OEKO-Tex 100 certified leatherette by default.



Therefore, it can be easily cleaned and, if necessary, also disinfected. When not used over a longer time period, we recommend to put a slipcover over it.

# Troubleshooting, Maintenance, & Care

## CLEANING THE ARTIFICIAL LEATHER COVER OF THE CHAIR

### Basics

Artificial leather is a comparatively resistant material. The following cleaning advice for its care is aimed at preserving the appearance and quality of your massage chair:

- As is true for all upholstered furniture, the cover material of your massage chair can fade or wear out more quickly by being exposed to direct sunlight or heat (for example by being placed next to a radiator). Finding the right place or using curtains or blinds can mitigate this process.
- Over time, artificial leather loses its plasticizers and can become dry and brittle. This process cannot be prevented but can be delayed by treating your massage chair with care and cleaning it regularly. It is possible to have the cover of your chair fully or partly replaced by us (prices upon request).

### Cleaning and care

**Step 1:** Moisten a soft cloth with lukewarm water, which contains a mild cleaning detergent (do not use solvents or abrasive products – please see our cleaning product recommendations on p. 29). The cloth should only be slightly moist. Wipe the chair down by moving from one area (enclosed by seams) to the next; move from the edges towards the center with circular motions.

**Step 2:** Afterwards, repeat the process with a soft cloth that is moistened with lukewarm water without any cleaning detergent.

**Step 3:** Dry off the cover with another dry, soft cloth.

# Troubleshooting, Maintenance, & Care



To clean and disinfect your massage chair properly we recommend using the reliable maintenance products by Sonett, obtainable from us or your local store. **NOTE:** We recommend to buy them **ONCE** from us with your initial purchase, if this specific product is not available in your area.

## Removing stains and dirt:

The quicker you remove dirt or stains, the better the result.

- Absorb spilled liquids with a clean, soft cloth and subsequently clean the affected area in three steps as described on the previous page.
- Do not scrape off dried-up dirt, but carefully lift it off with a blunt object (such as the blunt side of a knife) and subsequently clean the affected area in the previously described three steps.
- You could use a soft brush to treat tougher stains. Wet the brush with lukewarm water, which contains a small amount of a mild cleaning detergent. Then, clean the affected area in the previously described three steps.

**NOTE:** The advice given here does not constitute a guarantee and does not exempt you from your duty to exercise due diligence with your massage chair and the cleaning products you use. We assume no liability for any damage occurring during or from your cleaning and taking care of the chair.

# Product- and Packaging Measurements



1400 mm (approx. 4'59")



1120 mm (approx. 3'67")

740 mm (approx. 2'43")



1560 mm (approx. 5'12")

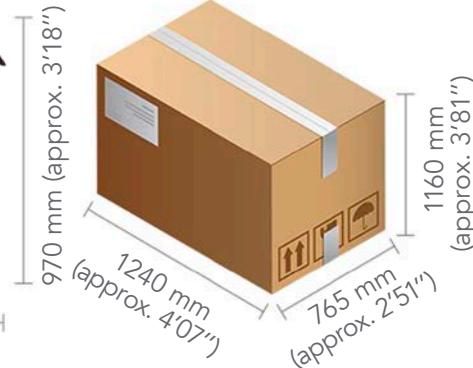

970 mm (approx. 3'18")

1240 mm (approx. 4'07")

765 mm (approx. 2'51")

1160 mm (approx. 3'81")

# Technical Specifications

## TECHNICAL SPECIFICATIONS

### Product description:

**brainLight**-4D-Shiatsu-Massage Chair **SPHERE**

Vertical range of the massage rolls: **125 cm**

Position angles of the chair: **130° – 155°**

Operating voltage: **AC 220 – 240 V; (50 Hz – 60 Hz)**

Wattage: **170 W**

Motor voltage: **DC 24 V**

Weight: **75 kg +/- 3 kg**



Dimensions: **approx. L 140 cm x B 74 cm x H 112 cm**  
**approx. L 4' 6" x W 2' 4" x H 3' 7" (feet & inches)**

Dimensions when chair is fully reclined and the footrest positioned horizontally:

**approx. L 156 cm x B 74 cm x H 97 cm**

**approx. L 5' 12" x W 2' 4" x H 3' 2" (feet & inches)**

For a holistic relaxation of mind and body the **brainLight**-4D-Shiatsu-Massage Chair **SPHERE** can be combined with the **brainLight relaxTower** or the **brainLight** Synchro to a **brainLight**-Complete-System ([www.brainlight.de/produkte](http://www.brainlight.de/produkte)).

Please visit [www.brainlight.de/service](http://www.brainlight.de/service) for frequently asked questions (FAQs) and for technical details and product information available for download.

All rights reserved. No part of this work may be reproduced in any form (print, scan, photocopy, microfilm or any other method) without written permission by **brainLight** GmbH and no part of this work may be processed or copied using electronic devices.

© 2023 **brainLight** GmbH

# Relaxation technology Made in Germany!



**brainLight** GmbH • Hauptstraße 52 • 63773 Goldbach • Germany  
 Phone: +49 (0) 6021 59070 • Fax: +49 (0) 6021 590797 • E-mail: [info@brainlight.de](mailto:info@brainlight.de)

[www.brainlight.de](http://www.brainlight.de)

# brainLight®

LIFE IN BALANCE

◆◆◆ Since 1988 ◆◆◆